

VITO MIRA  
**186 4320**

STEFFI  
**186 4370**

VITO MIRA WEISS  
**186 4730**

STEFFI ZWART  
**186 5230**

STEFFI WEISS  
**186 4750**

NILS  
**186 4800**

MICHA  
**186 4538**

MARIELLA  
**176 5220**



# Warnhinweis!

Warning! / Avertissement! / 警告!  
 Waarschuwing! / Предупреждение!



TRANSLAND  
 Hauptstraße 87  
 D-97840 Hafenhof



V..

Vorbereitung / Preparation /  
 Préparation / Voorbereiding /  
 Подготовка / 准备

M..

Montage / Assembly /  
 Assemblage / Montage / Монтаж /  
 组装

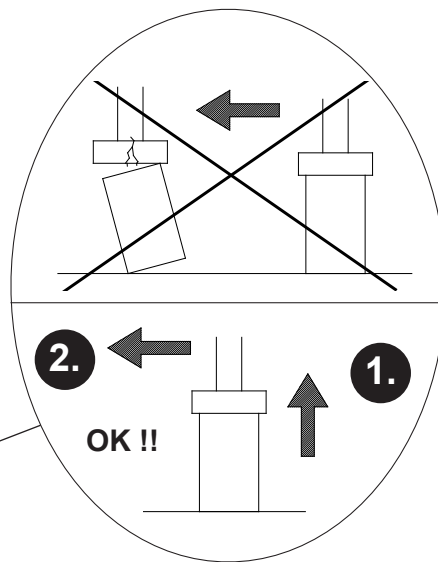
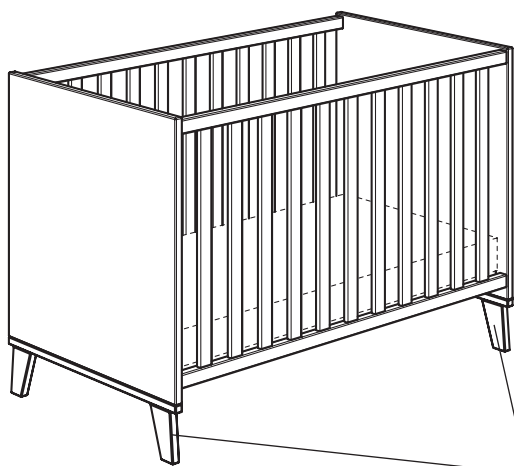
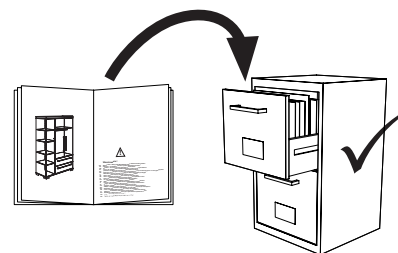

- DE** Schraubenverbindungen von Zeit zu Zeit auf ihre Festigkeit prüfen, gegebenenfalls nachziehen, da die Stabilität der Konstruktion sonst nicht gegeben ist.
- FR** Vérifier les connexions à vis de temps en temps, resserrer celles-ci le cas échéant, car, sinon, la stabilité de la construction ne serait pas assurée.
- GB** Check the tightness of the screw connections from time to time and tighten if necessary, as otherwise the stability of the construction is not assured.
- NL** Schroefverbindingen moeten van tijd tot tijd op hun stevigheid worden gecontroleerd en eventueel worden vastgedraaid, aangezien de stabiliteit van de constructie anders niet verzekerd is.
- ES** Compruebe de vez en cuando la firmeza de las uniones atornilladas y reapriete los tornillos si fuera necesario, pues de lo contrario quedaría afectada la estabilidad de la estructura.
- GR** Πού και πού ελέγχετε τη σταθερότητα των κοχλιωτών συνδέσεων κι εφ' όσον είναι ανάγκη, τις σφίγγετε ξανά, επειδή διαφορετικά δεν είναι η ευστάθεια της κατασκευής δεδομένη.
- IT** Controllare di tanto in tanto la tenuta delle connessioni a viti, all'occorrenza provvedere a serrarle di nuovo, poiché altrimenti non è garantita la stabilità della struttura.
- CZ** Čas od času zkontrolujte pevnost šroubových spojů, případně je dotáhněte, jinak nebude konstrukce stabilní.
- SL** Vijačne zveze od časa do časa preveriti glede na trdnost, po potrebi priviti, saj sicer stabilnost konstrukcije ne bo zagotovljena.
- PL** Połączenia śrubami sprawdzać od czasu do czasu pod kątem ich trwałości, ewentualnie dokręcać, gdyż inaczej konstrukcja nie jest stabilna.
- BG** Контролирайте от време на време дали болтовите съединения са добре завинтени, тъй като в противен случай не може да се гарантира стабилността на конструкцията.
- HR** Spojeve vijaka s vremena na vrijeme provjeriti u svezi čvrstoće, po potrebi stegnuti, jer inače nije zajamčena stabilnost konstrukcije.
- LT** Kartais patikrinkite varžtų jungčių stiprumą, prireikus suvėžkite juos stipriau, nes priešingu atveju konstrukcija nebus stabilii.
- RU** Перепроверяйте время от времени болтовые соединения. Они должны быть плотно затянуты. Это гарантирует стабильность конструкции.
- CN** 请经常的检查连接处的螺丝，如有发现松动请及时锁紧，否则将无法保障其稳定性。

- DE** Pflegehinweis: Zum Reinigen der Oberflächen ein leicht-feuchtes Tuch oder ein handelsübliches Möbelpflegemittel verwenden.
- FR** Indication sur l'entretien: pour nettoyer les surfaces, utiliser un chiffon légèrement humide ou un nettoyeur pour meubles en vente dans le commerce.
- GB** Caring for the...: In order to clean the surfaces please use a slightly damp cloth or commercially available furniture care product.
- NL** Verzorgingsanwijzing: Voor het reinigen van de oppervlakken een licht vochtig doek of een gebruikelijk meubelschoonmaakmiddel gebruiken.
- ES** Recomendaciones de cuidado: Para limpiar las superficies del mueble debe usar un trapo humedecido o un producto de limpieza de muebles comercial.
- GR** Οδηγίες περιποίησης: Για το καθάρισμα των επιφανειών να χρησιμοποιείτε ένα ελαφρά νοτισμένο πανάκι ή λούστρο επίπλων.
- IT** Indicazione per pulizia e cura: Per la pulizia delle superfici utilizzate un panno leggermente umido o un normale prodotto per la cura dei mobili.
- CZ** Pokyny k čištění: Na čištění povrchu použijte pouze navlhčený kousek látky nebo běžný prostředek na ošetřování nábytku.
- SL** Navodilo za nego: Za čiščenje površin uporabljajte malo vlažno cunjlo ali trgovsko običajno sredstvo za nego pohištva.
- PL** Wskazówka pielęgnacyjna: do czyszczenia powierzchni stosować lekko wilgotną ściereczkę lub zwykły środek do pielęgnacji mebli.
- BG** Указание за поддръжане: Използвайте леко навлажнена кърпа или обикновен препарат за поддръжане на мебели, за да почистите повърхностите.
- HR** Upute za njegu: Za čišćenje površina upotrijebiti jednu lako navlaženu krpu i trgovačko uobičajeno sredstvo za njegu namještaja.
- LT** Rekomendacija priežiūrai: Paviršius valykite drėgna pašluoste arba parduotuvėse įsigytomis baldų priežiūros priemonėmis.
- RU** Рекомендации по уходу: для очистки поверхностей используйте слегка влажную тряпку или обычное средство по уходу за мебелью.
- CN** 保养说明: 清洁表面只需用稍微潮湿的布或普通的家具清洁剂即可。
- AR** إرشاد للعناية: يرجى من أجل تنظيف الأسطح استخدام منديل رطب بعض الشيء أو استخدام إحدى مواد تنظيف الأثاث المتوفرة في الأسواق التجارية.

# Beschläge

Fittings / Raccords / Hulpstukken /  
Фурнитура / 配件

TRANSLAND  
Hauptstraße 87  
D-97840 Hafenlohr



1:1  
DIN A4

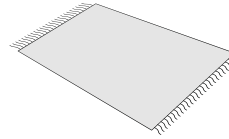
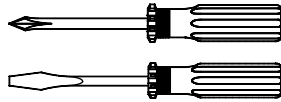
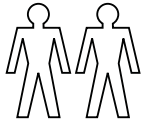
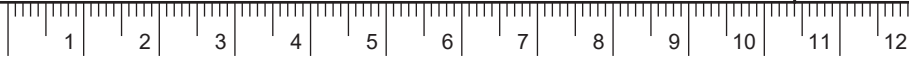

ca. 0,5h

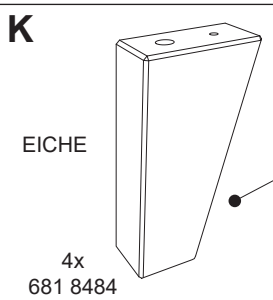
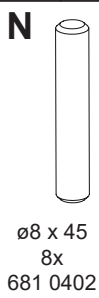
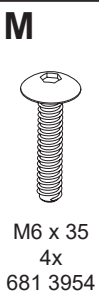
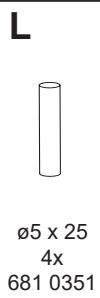
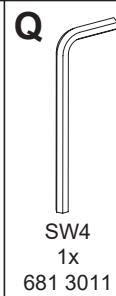
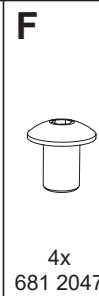
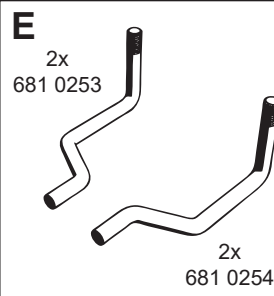
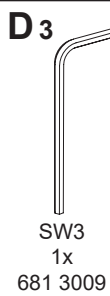
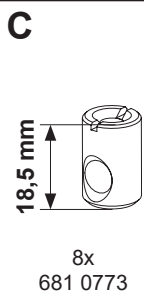
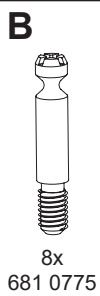
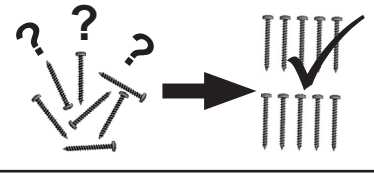

Betr. Programm  
VITO MIRA / STEFFI /  
VITO MIRA WEISS / STEFFI WEISS /  
STEFFI ZWART / MARIELLA

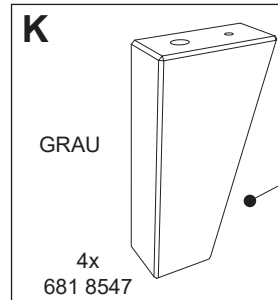



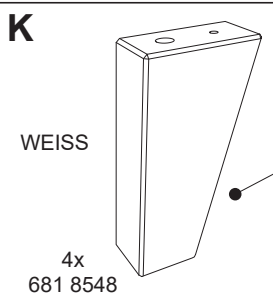

Betr. Programm  
NILS

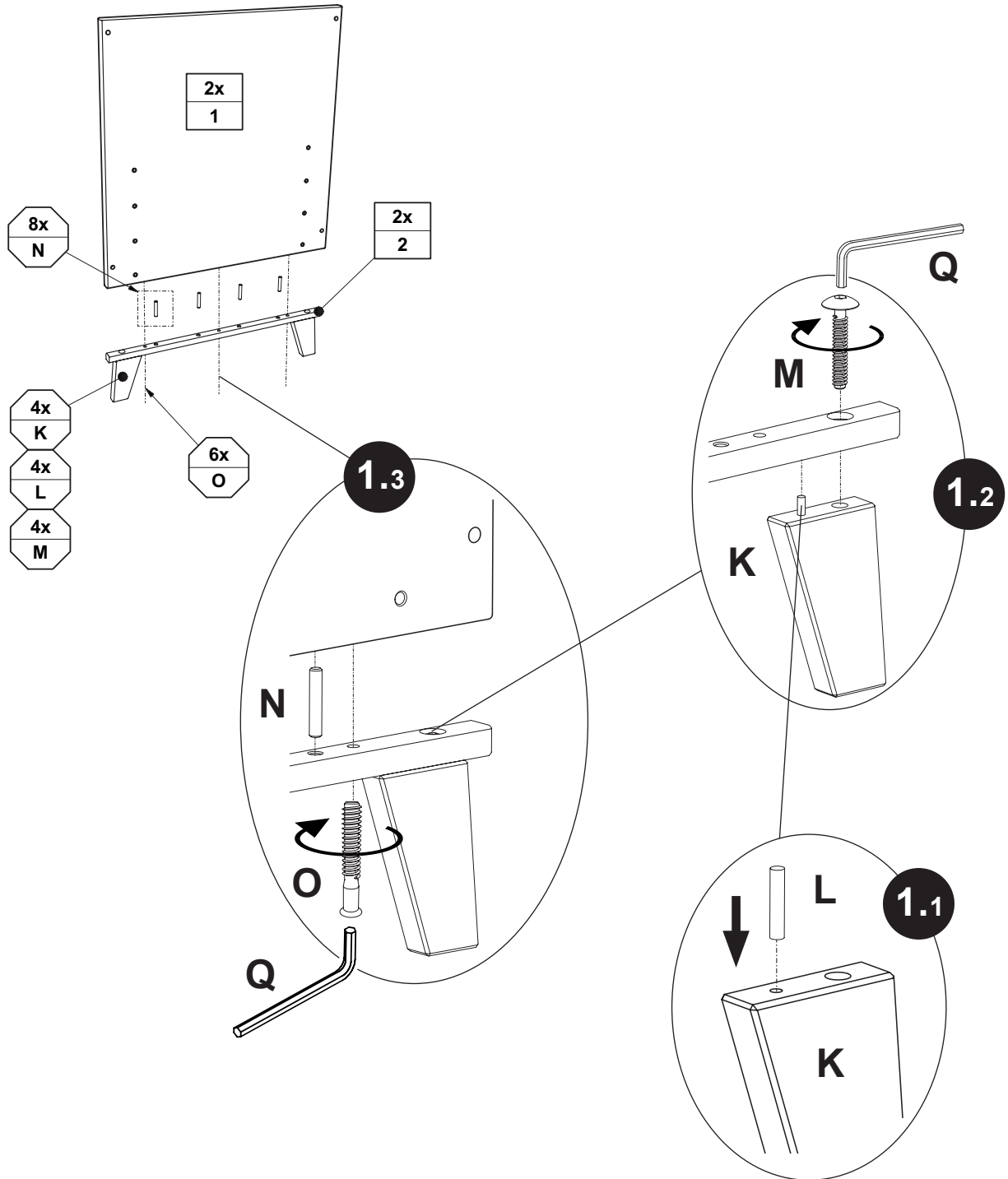

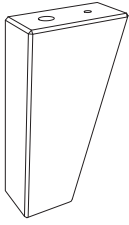
Betr. Programm  
MICHA

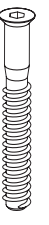

K	L	M	N	O
				
4x 681 8484 / 681 8547 / 681 8548	ø5 x 25 4x 681 0351	M6 x 35 4x 681 3954	ø8 x 45 8x 681 0402	6,3 x 50 6x 681 5311

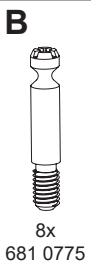
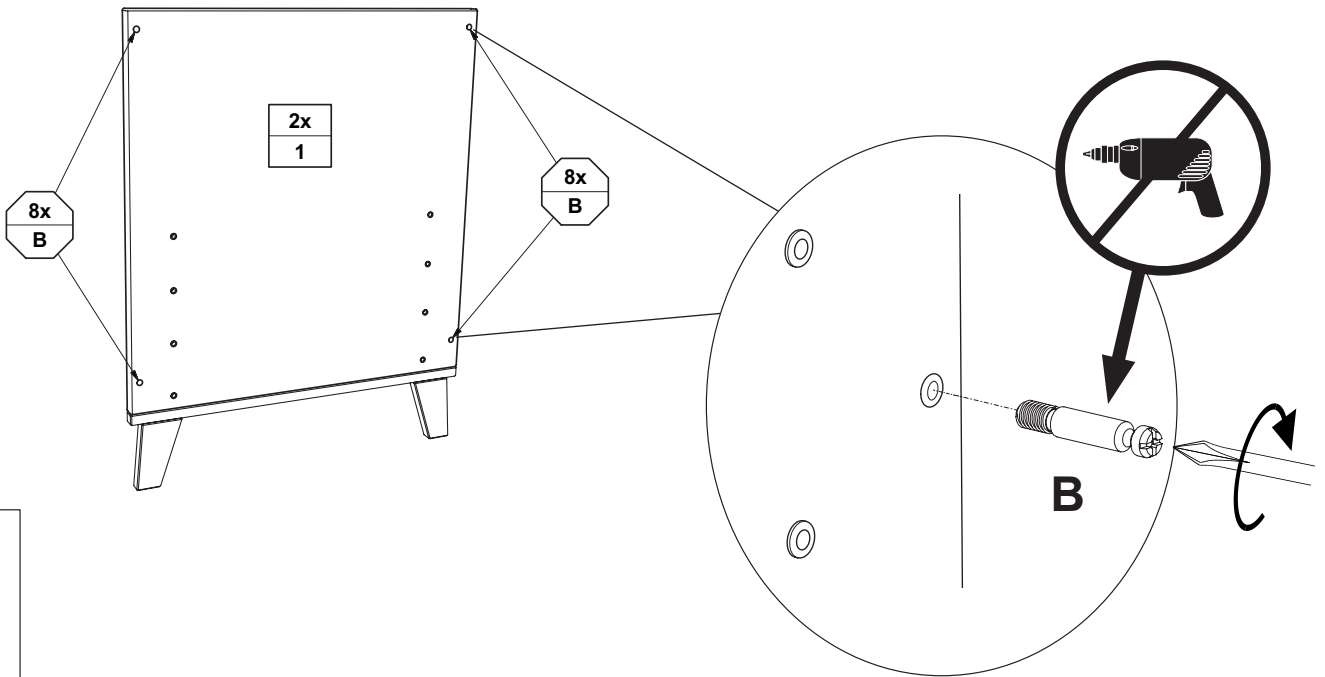

V2

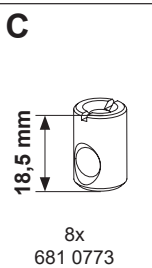
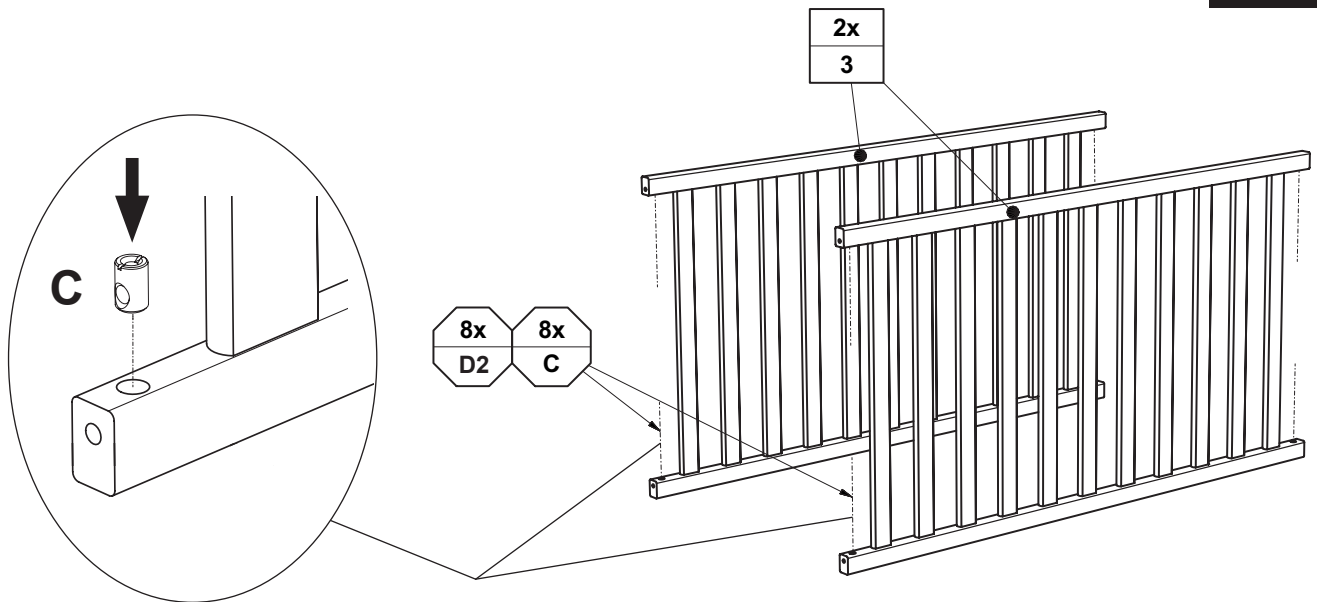

V3

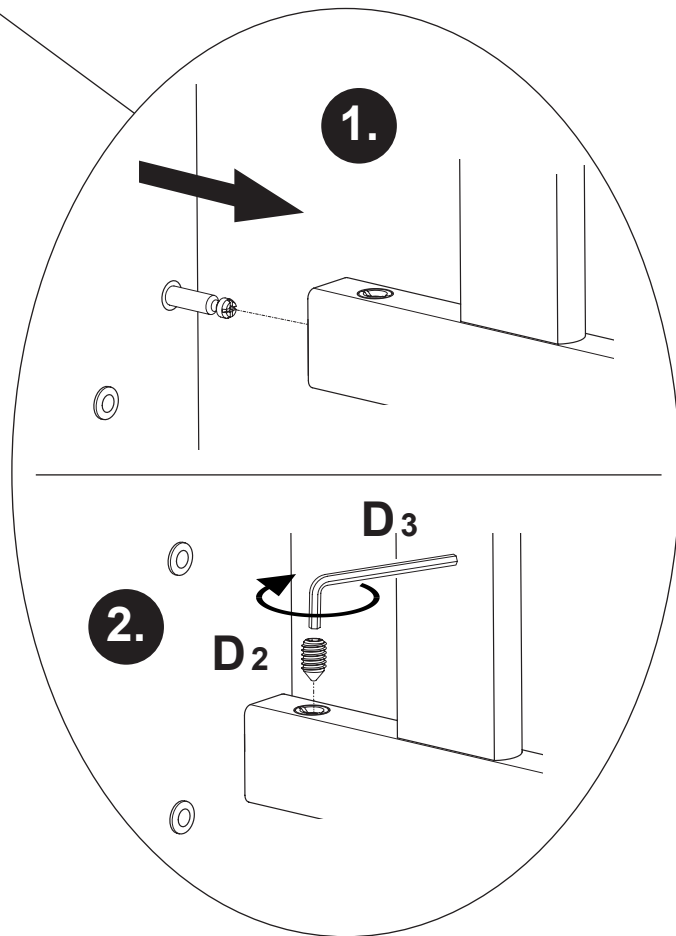
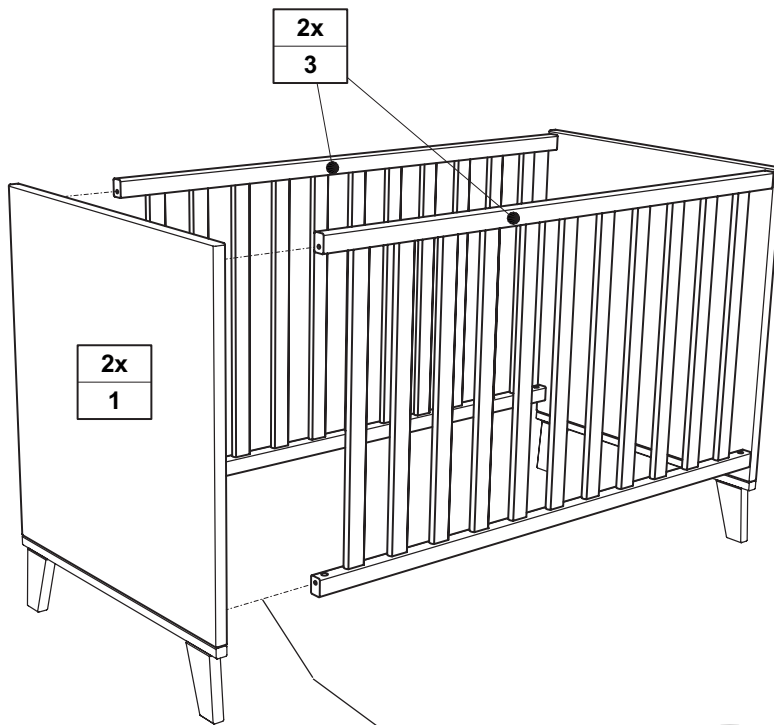



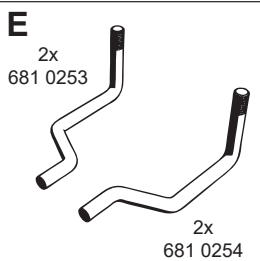
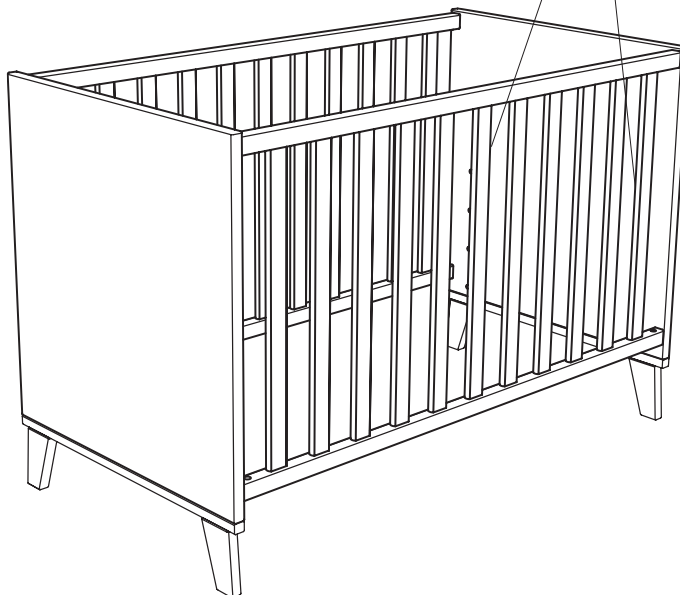
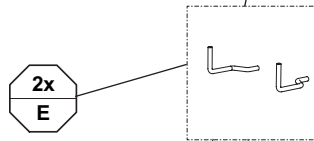
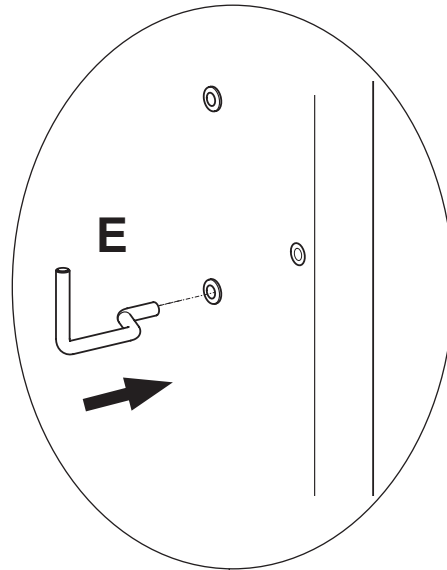
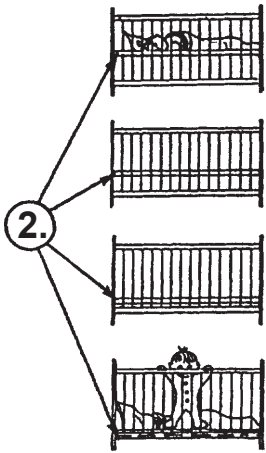

<b>D2</b>	<b>D3</b>
	
8x	SW3
681 0784	1x
	681 3009

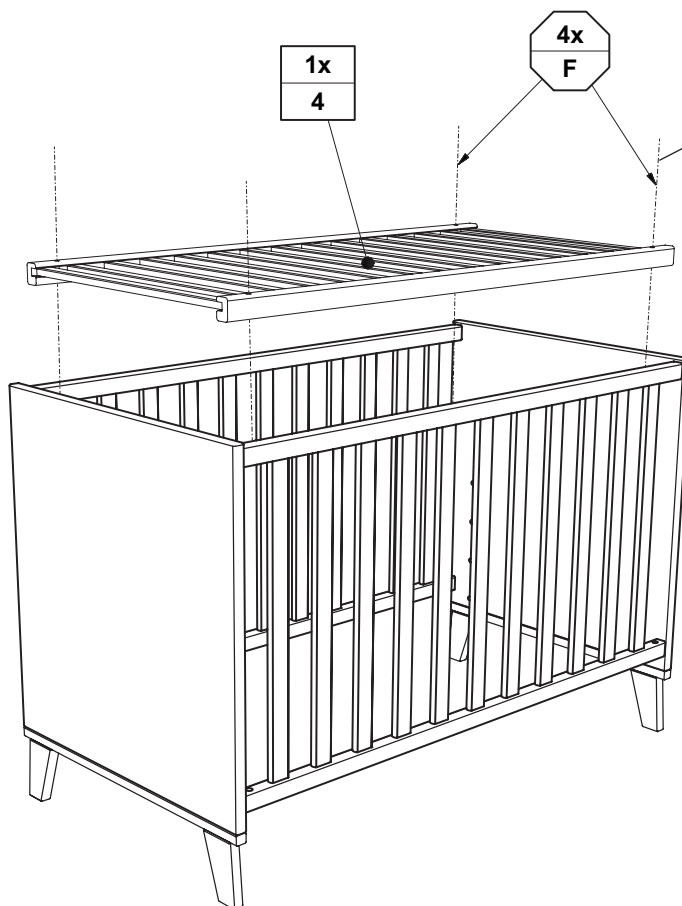
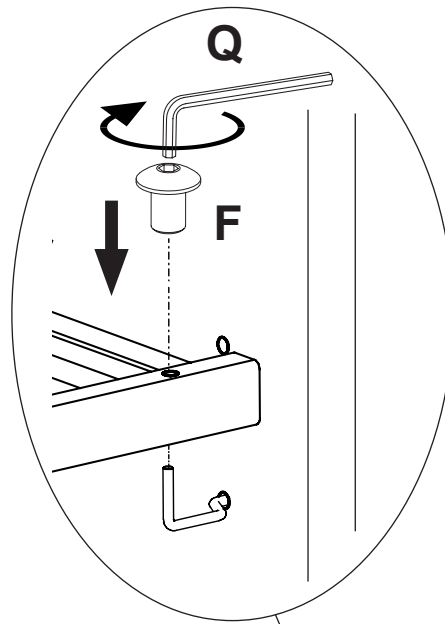



F	Q
	
4x 681 2047	SW4 1x 681 3011